

Varenummer: 203280M1060A1S  
 Beskrivelse: E+G Justerfod  
 GN 32-80-M10-60-A1-S  
 Note: S Uden møtrik, udvendig sekskant i bunden

## Mål

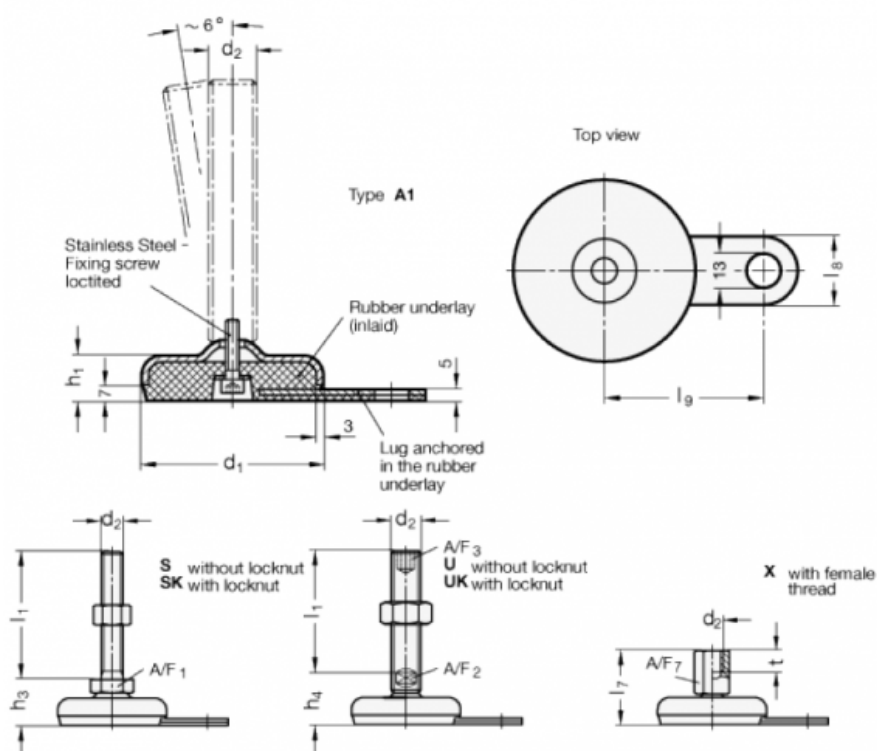

A/F1	= 17
d1	= 80
d2	= M10
h1	= 20
h3	= 28
l1	= 60
l8	= 30
l9	= 70